

Maßvorlage

Platzierung - Aluminiumpfosten mit Fuß - Glasmontage außenseite

Außenecke

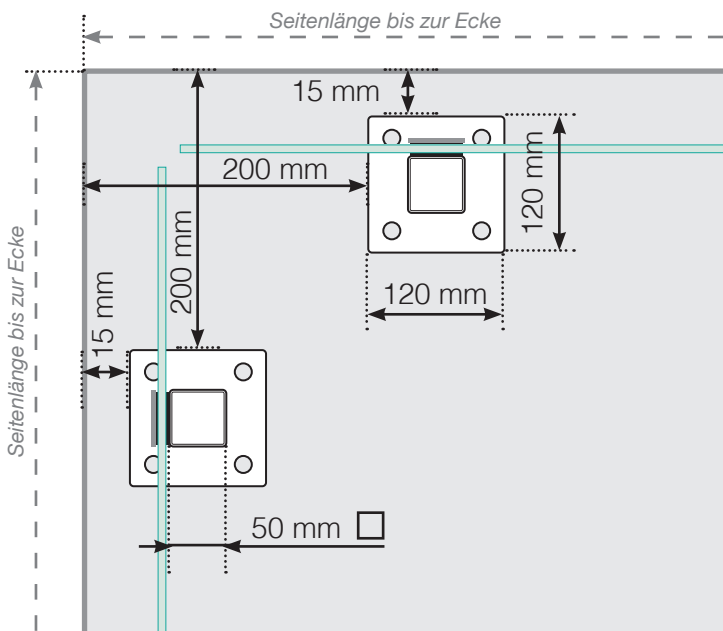

Außenecke > 90°

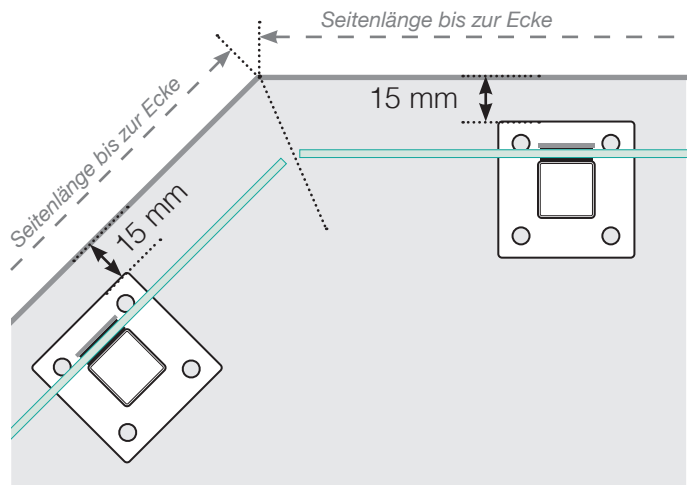

Innenecke > 90°

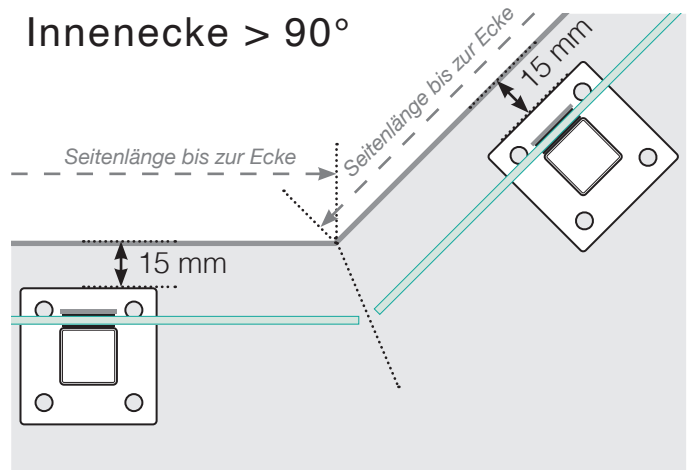

Innenecke

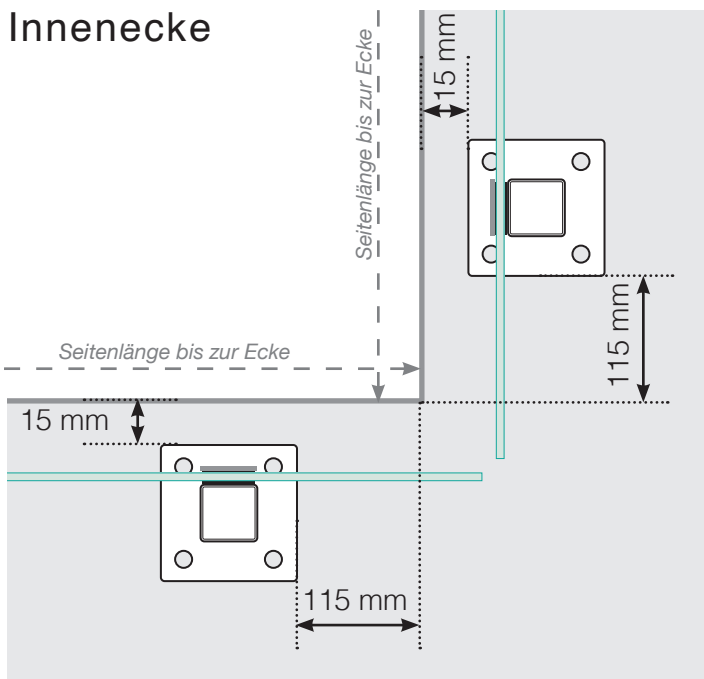

Endpfosten

Freies Ende

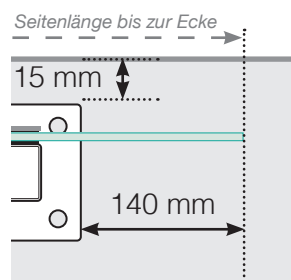

An einer Wand

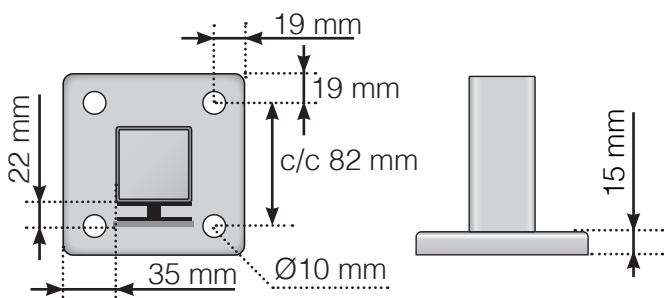
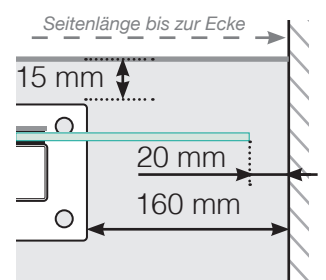

Abstand bei geraden Sektionen

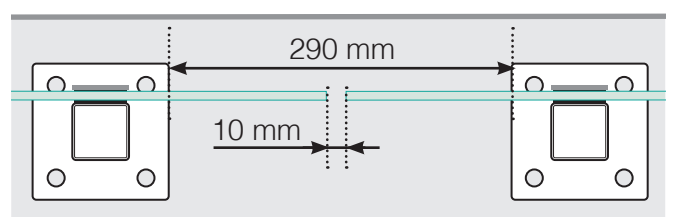

Achtung: Die Zeichnungen sind nicht maßstabgetreu

© Räckesbutiken Sweden AB - www.gelaenderladen.ch

23.9.2020 v.1.0



GELÄNDERLADEN.CH